

PMMN4148

RM110 Remote Speaker Microphone, with 3.5 mm Audio Jack (IP55)



MN009679A01-AB



MOTOROLA, MOTO, MOTOROLA SOLUTIONS and the Stylized M logo are trademarks or registered trademarks of Motorola Trademark Holdings, LLC and are used under license. All other trademarks are the property of their respective owners.
© 2023 Motorola Solutions, Inc. All rights reserved.

Printed In



**Foreword
RF Energy Exposure and Product Safety
Guide for Portable Two-way Radios**

Attention!

Before using this accessory, read this guide which contains important operating instructions for safe usage and RF energy awareness and control for compliance with applicable standards and regulations.

The Remote Speaker Microphone (RSM), when attached to the radio, is restricted to occupational use only to satisfy FCC/ICNIRP RF energy exposure requirements. Before using this product, read the RF energy awareness information and operating instructions in the Product Safety and RF Exposure booklet enclosed with your radio to ensure compliance with RF energy exposure limits.

Acoustic Safety

Exposure to loud noises from any source for extended periods of time may temporarily or permanently affect your hearing. The louder the volume of the radio, the less time is required before your hearing can be affected.

Hearing damage from loud noise is sometimes undetectable at first and can have a cumulative effect.

To protect your hearing:

- Use the lowest volume necessary to do your job.
- Turn up the volume only if you are in noisy surroundings.
- Turn down the volume before attaching headset or earpiece.
- Limit the amount of time you use headsets or earpieces at high volume.
- When using the radio without a headset or earpiece, do not place the speaker of the radio directly against your ear.
- If you experience hearing discomfort, ringing in your ears, or muffled speech, you should stop listening to your radio through your headset or earpiece, and have your hearing checked by your doctor. To change the volume level, refer to Radio Product Safety Leaflet or CPS for Surveillance extra loud (xL) Kit Configurations.

RSM Features

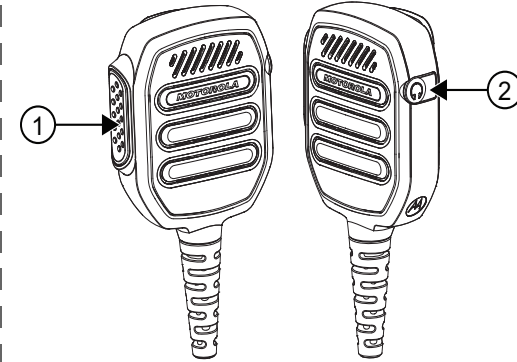
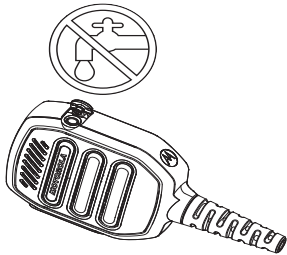

Table 1: RSM Features

| No. | Description |
|-----|---|
| 1 | Push-to-Talk Button |
| 2 | Receive-only 3.5 mm Audio Jack (Non-threaded) covered by Dust Cover |

Recommended Practice



- Cover the audio jack with dust cover when it is not plugged with earpiece.
- Do not fill water into the audio jack.
- If water enters the audio jack, remove water by shaking the RSM.

Transmitting and Receiving

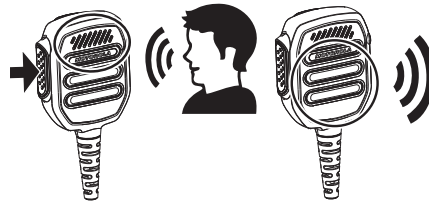

Recommended RSM Wearing Position

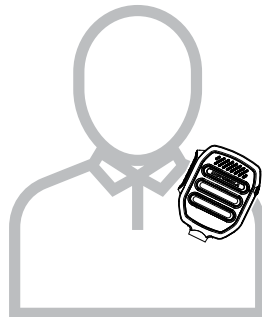

Attaching the RSM to the Radio

Attach the RSM connector to the side connector of the radio. Then secure the connection screw in a clockwise direction until tightened.

Note: To ensure proper operation, turn off the radio before connecting the RSM to the radio. Connecting the RSM to the radio disables the speaker of the radio, but does not disable the microphone and PTT of the radio.

Detaching the RSM from the Radio

1. Unscrew and detach the RSM connector from the radio side connector.
2. Keep the dust cover inserted in the audio jack of the RSM when a secondary accessory is not being used.

Cable Management

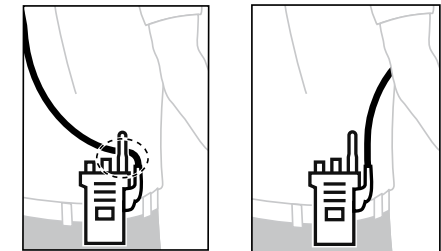

To ensure optimum range and user experience, it is recommended to avoid crossing accessory cable with the radio antenna.

Optional Accessories

Table 2: Optional Accessories

| Part Number | Description |
|-------------|--|
| PMLN8120 | Rx only xL Clear Tube Earpiece, 3.5mm Jack |

Replacement Parts

Table 3: Replacement Parts

| No | Description |
|----|------------------------------------|
| 1 | Low Profile Swivel Clip (PMLN8121) |
| 2 | Dust Cover 10pcs/pack (PMLN8253) |

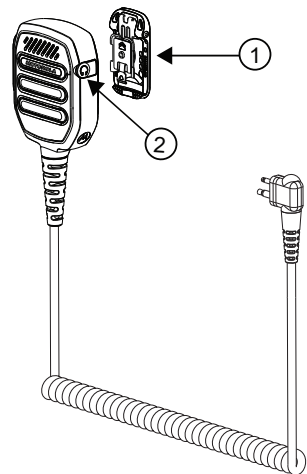

Service and Warranty

Motorola Solutions offers warranty for your RSM. Refer to your Motorola Solutions dealer or point-of-purchase for detailed information.

NOTE: Warranty is void after customer replacement of any parts other than replacements parts listed.

Removing the Dust Cover

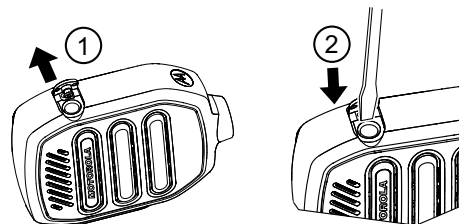

1. Lift up dust cover until it is fully open.
2. Insert small flat tip tool into recess & pry out the dust cover.

Inserting the Dust Cover

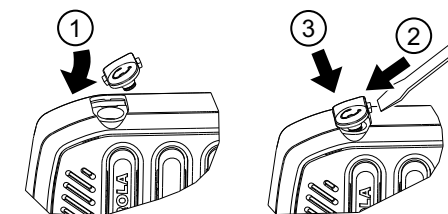

1. Slide the side tab of Dust Cover into the recess slot.
2. Push the opposite side with small tool.
3. Simultaneously push the Dust Cover into the RSM.

Attaching Swivel Clip

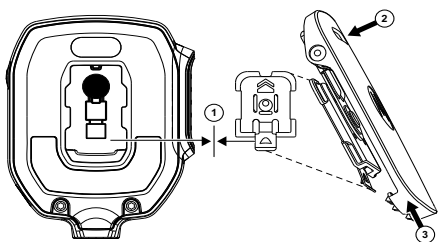

1. Align the Bottom Release Latch to facing the downwards position.
2. Push down the top of the clip.
3. Simultaneously, slide the clip upward.

Detaching Swivel Clip

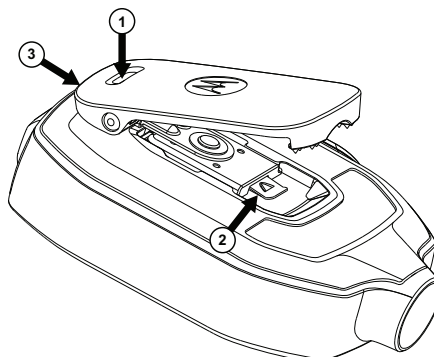

1. Push top of the clip to raise the clip to the highest position.
2. Lift up the bottom release latch.
3. Slide the clip to remove the clip.

Refer to manual MN009681A01 for other languages: <https://learning.motorolasolutions.com>



EU Contact:

Motorola Solutions, Czerwone Maki 82, 30-392 Krakow, Poland.

UK Address:

Motorola Solutions UK Ltd., Nova South, 160 Victoria Street, London, SW1E 5LB, United Kingdom.