

ROHS

ISO 9001
ISO 14001

single-packing sticker

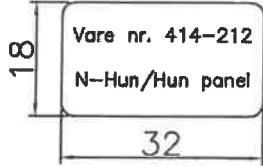

single-packing zipper bag

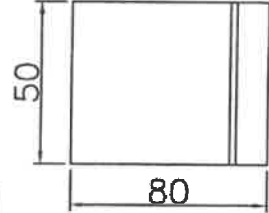

10pcs PE bag

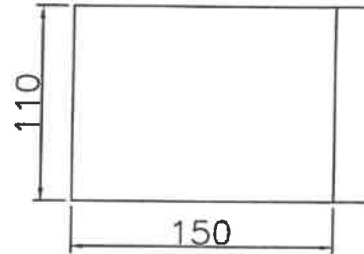

10pcs sticker

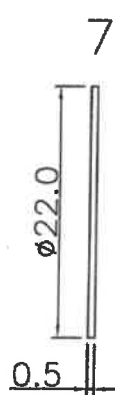
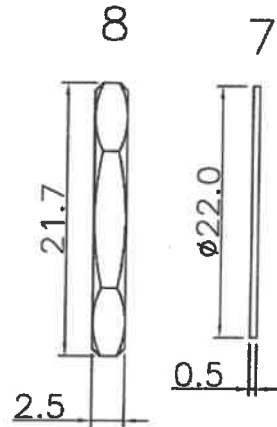
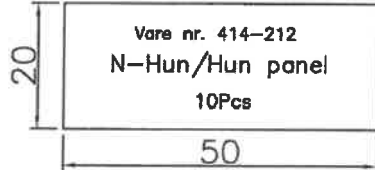

5/8"-24(φ15.5)

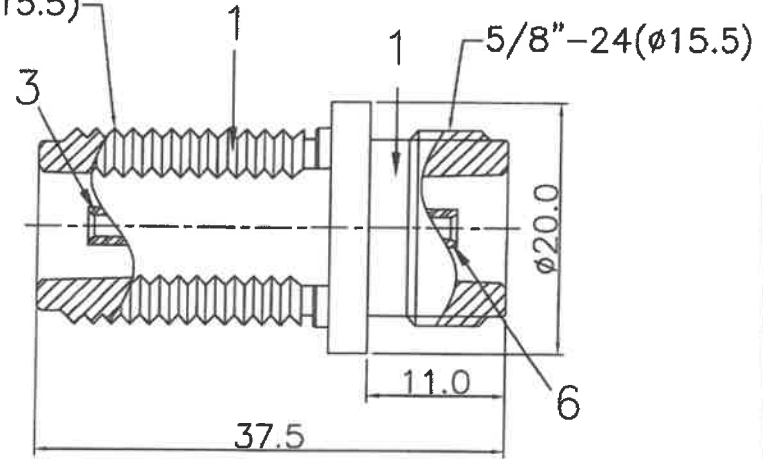
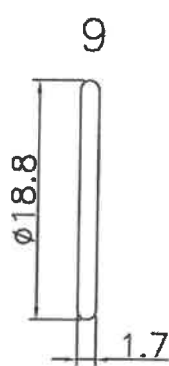

9	GASKET	RUBBER / BLACK	1
8	NUT	BRASS / NI	1
7	WASHER	BRASS / NI	1
6	PIN	PHOSPHOR BRONZE / GOLD	1
5	INSULATOR	PTFE / WHITE	1
4	BODY	BRASS / NI	1
3	PIN	PHOSPHOR BRONZE / GOLD	1
2	INSULATOR	PTFE / WHITE	1
1	BODY	BRASS / NI	1
NO	DESCRIPTION	MATERIAL / FINISH	Q'TY

Material:		Treatment:		TRANSVOICE			
Drawer	Design	Aprov	Tolerance	Unit: mm		TITLE	N F TO N F(BH)
			X=±0.5 .X=±0.2 .XX=±0.1 .XXX=±0.05	Ver: A	Scale 2:1	Model NO	414-212
Part NO	XP-CR277-6095			File NO: QR0402	Drawing NO	100-27001-122	