

# 1-Wire Enh Clear Tube Earpiece, 2.5 mm Single Pin, Angled, PMLN8191



MN006810A01-AA

MOTOROLA, MOTO, MOTOROLA SOLUTIONS and the Stylized M logo are trademarks or registered trademarks of Motorola Trademark Holdings, LLC and are used under license. All other trademarks are the property of their respective owners.  
© 2020 Motorola Solutions, Inc. All rights reserved.

Refer to manual MN006816A01 for other languages:  
<https://learning.motorolasolutions.com/>



EU Contact: Motorola Solutions,  
Czerwone Maki 82, 30-392 Krakow, Poland

Printed in



## Attention!

Before using this product, read the RF Energy Exposure and Product Safety Guide that ships with the radio which contains instructions for safe usage and RF energy awareness and control for compliance with applicable standards and regulation.

## Acoustic Safety

Exposure to loud noises from any source for extended periods of time may temporarily or permanently affect your hearing. The louder the radio volume, the less time is required before your hearing can be affected. Hearing damage from loud noise is sometimes undetectable at first and can have a cumulative effect. To protect your hearing:

- Use the lowest volume necessary to do your job.
- Turn up the volume only if you are in noisy surroundings.

- Turn down the volume before attaching headset or earpiece.
- Limit the amount of time you use headsets or earpieces at high volume.
- When using the radio without a headset or earpiece, do not place the radio speaker directly against your ear.
- If you experience hearing discomfort, ringing in your ears, or muffled speech, you should stop listening to your radio through your headset or earpiece, and have your hearing checked by your doctor.

To change the volume level, refer to Radio Product Safety Leaflet.

## Recommended Practice



Caution

- Do not cover the microphone port for optimum performance.
- Do not fill the earpiece with water.
- Clean the earpiece with soft damp cloth.
- Do not use the earpiece until completely dry

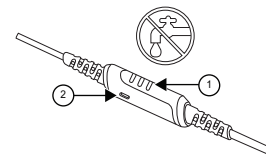
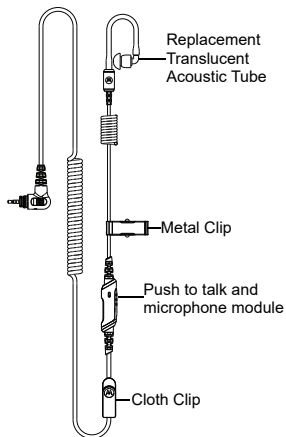

Table 1: 1-Wire Enh Clear Tube Earpiece Overview and Description

Indicator	Description
1	Push-to-Talk (PTT) Button
2	Microphone

## Earpiece Overview



## Recommended Wearing Position

For optimized microphone performance, place the microphone close to your mouth during PTT.

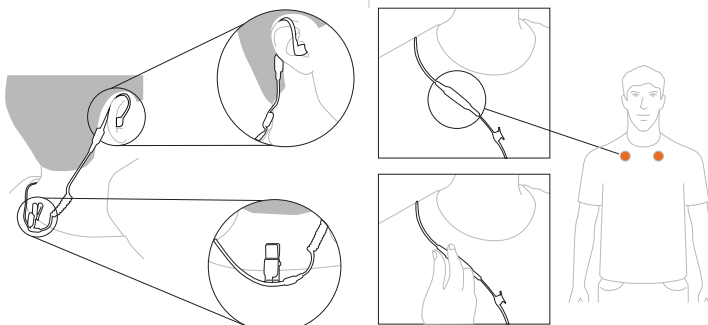

## Translucent Acoustic Tube Replacement

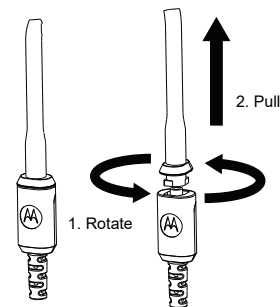

Caution

### Operation

- Turn off the device while attaching and detaching the earpiece.

## Attaching the Earpiece

Turn off the device when attaching the earpiece.

1. Insert the audio jack connector into the device audio jack.

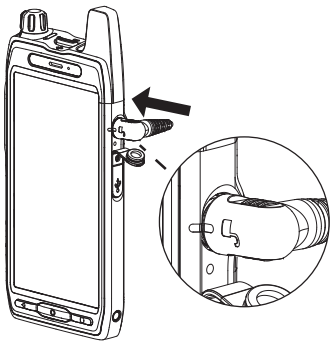

2. Rotate the audio jack connector 90 degrees upwards to lock.

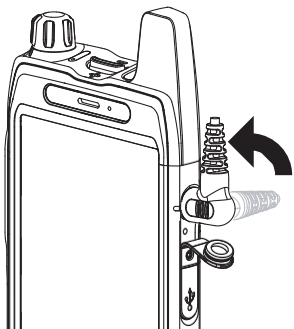

## Detaching the Earpiece

Turn off the device when detaching the earpiece.

1. Rotate the audio jack connector 90 degrees to unlock.

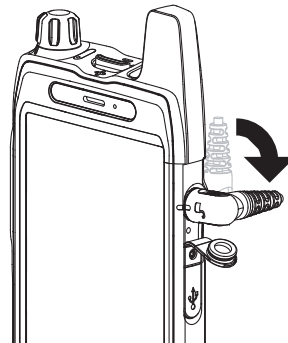

2. Gently pull out the earpiece from the radio.

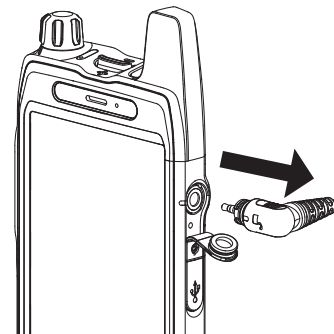

## Replaceable Parts

**Table 2: Earpiece Replaceable Parts**

Part Number	Quantity per pack	Description
PMLN8079_	10	Cloth Clip
PMLN8092_	1	Acoustic Tube with Rubber Earbud
RLN4760_	1	Right Earpiece (Size S)
RLN4761_	1	Right Earpiece (Size M)
RLN4762_	1	Right Earpiece (Size L)
RLN4763_	1	Left Earpiece (Size S)
RLN4764_	1	Left Earpiece (Size M)
RLN4765_	1	Left Earpiece (Size L)

**Table 2: Earpiece Replaceable Parts (Continued)**

Part Number	Quantity per pack	Description
RLN6511_	1	Ultra Earplugs (Size S)
RLN6512_	1	Ultra Earplugs (Size M)
RLN6513_	1	Ultra Earplugs (Size L)

## Warranty

Motorola Solutions offers a standard one year warranty. Contact your Motorola Solutions dealer for detailed information on the standard warranty.

## For More Information

Contact Motorola Solutions Authorized Dealer or visit us at [www.motorolasolutions.com](http://www.motorolasolutions.com).

## NOTES

## NOTES